



ASSEMBLY INSTRUCTION ONIX



Complexity	Time	Instruments	People
★☆☆☆☆	 10min		

- Thank you for choosing our furniture! We hope you enjoy this new purchase in your office or home for many years to come.
- Please read the assembly instructions carefully. Assemble the piece of furniture according to the numerical order of the drawings (1,2,3..).

- **BEFORE YOU BEGIN**

- **PRESENTATION OF MATERIALS**

- Check the correspondence of the parts and components delivered in the package with the specification list

- **ADEQUATE SPACE**

- Identify a sufficiently spacious interior space depending on the dimensions of the product. Recommended - in close proximity to the future location of the product.

- **AVOID DAMAGE**

- This product must be assembled on a suitable flat and soft surface (eg cardboard, carpet) to prevent any damage or scratches.

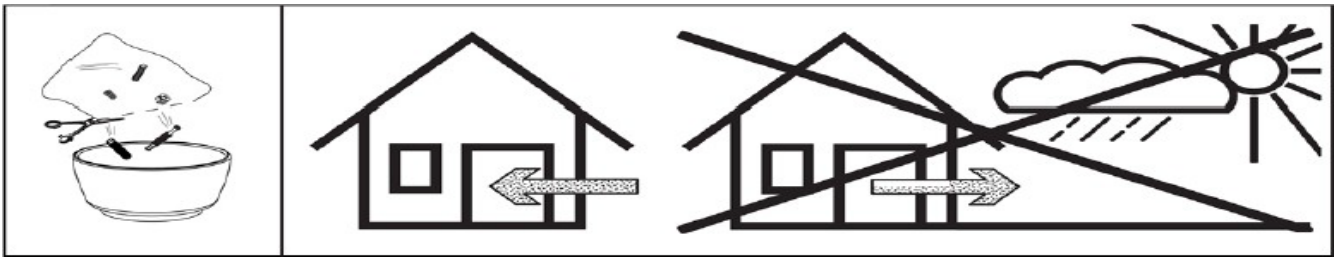

- The assembly of the piece of furniture must be done according to the assembly instructions by a competent person. Read carefully, keep this information for future reference.
 - Keep assembly parts away from infants and small children. Keep the hardware bag, hardware and packaging out of the reach of infants and small children, as they contain small parts that can be swallowed and pose a risk of suffocation.
 - For damages that may arise from: non-observance of the instructions for use, operation or assembly, as well as the replacement of constructive elements, the modification of products or the use of consumables that do not correspond to the original parts, attracts our exemption. out of responsibility. The commercial company is not responsible for personal or material damage that may occur as a result of improper installation, respectively as a result of not being fixed to the wall or overloading. Observe the maximum weight in the assembly instructions.
-

- **MAINTENANCE AND USE**

- After assembly, periodically wipe the dust with a soft damp cloth on the surface of the furniture. Do not use solvents or thinners for cleaning! After a few weeks of daily use, to maintain the stability of the piece of furniture, it may be necessary to retighten the screws. It will be stored in a well-ventilated room, avoiding prolonged exposure to extreme temperatures, away from direct sunlight and other sources of continuous heat. Avoid placing hot objects on the surfaces of the piece of furniture. To move the furniture product, we recommend that you lift it, holding it by the frame. Do not push or move the furniture product if it is loaded. Doing so will make the furniture product unstable, causing the risk of imbalance, tipping over and injury.

PARTS PROVIDED

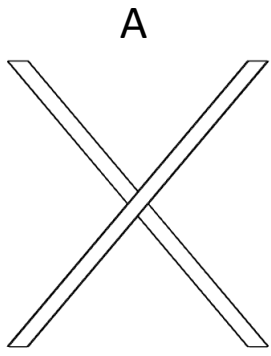

2X

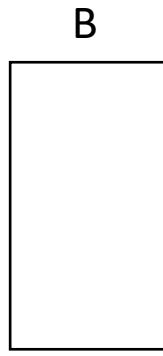

1X

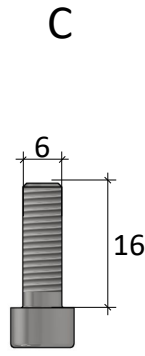

16X

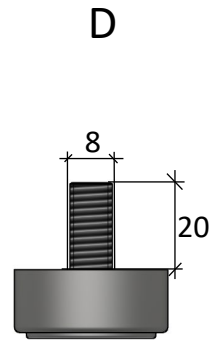

4X

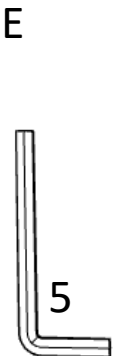

1X

STEP 1

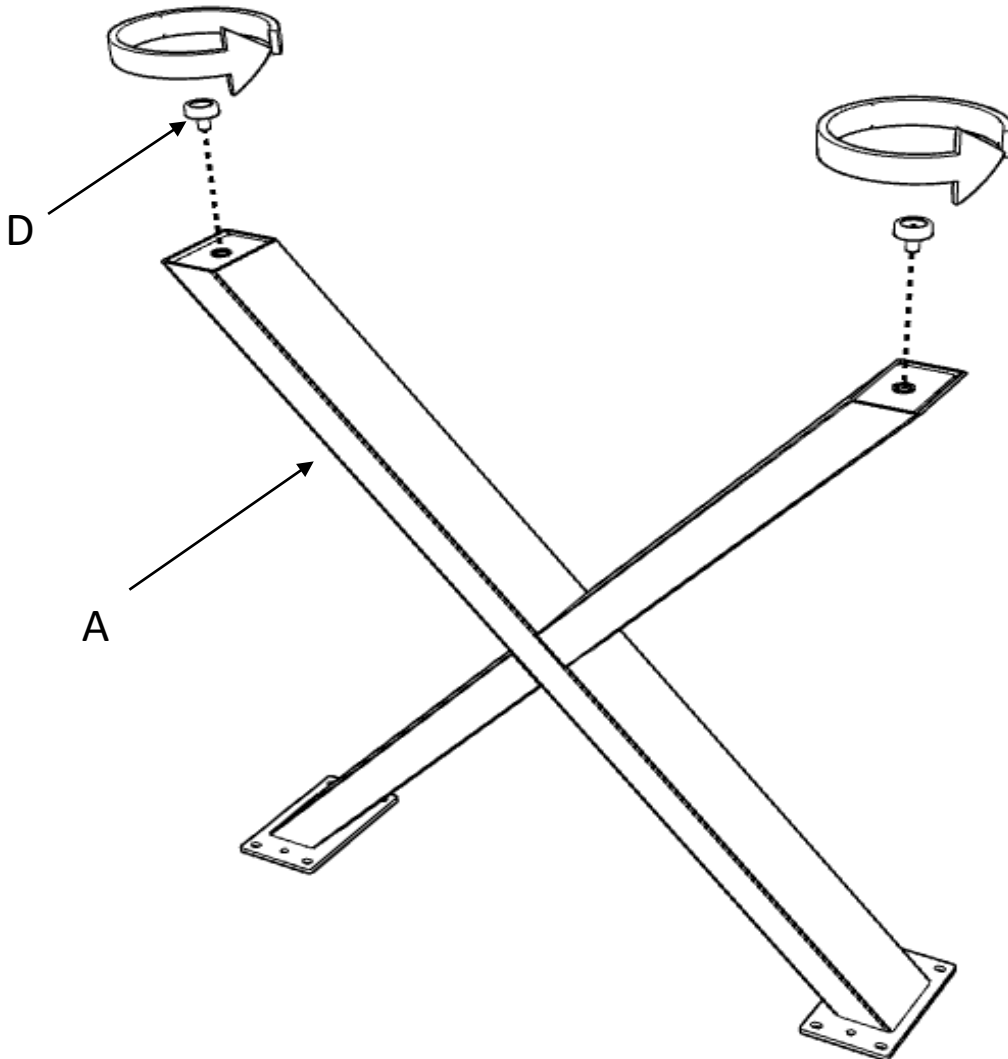

STEP 2

